

ACVATIX™

Electromotive actuators for VPI46..

SAY..P..



Actuators with 15 mm stroke and 200 N force

- SAY31P03 Operating voltage AC 230 V, positioning signal 3-position
- SAY61P03 Operating voltage AC/DC 24 V, positioning signal 0...10V, 4...20 mA
With position feedback, forced control, characteristic changeover
- SAY61P03/MO operating voltage AC/DC 24 V,
RS-485 for Modbus RTU communication
- SAY81P03 Operating voltage AC/DC 24 V, positioning sign 3-position
- For direct mounting on valves; no adjustments required
- Manual adjuster, position and status indication (LED)
- Optional functional extension with auxiliary switch

Use

Electromotive actuators to operate Siemens combi valves for type series VPI46.40F9.5Q and VPI46.50F12Q with 15 mm stroke, as control valves on ventilation, air conditioning, district heating and refrigeration plants.

Functions

Function	Description	Type
3-position control	A 3-position signal controls the actuator via connection terminals Y1 or Y2. The desired position is transmitted to the valve.	SAY31P03, SAY81P03
Modulating control	The modulating positioning signal provides stepless motor control. The positioning signal range (DC 0...10 V / DC 4...20 mA / 0...1000 Ω) corresponds to the positioning range (closed...open, or 0...100% stroke) in a linear manner.	SAY61P03
Positioning signal and characteristic changeover	Setting with DIL switch. Factory setting: <ul style="list-style-type: none"> Characteristic curve: log = Equal percentage (switch set to Off) Positioning signal: DC 0...10 V (switch set to Off) 	SAY61 P03, SAY61P03/MO
Position feedback U	Signal returned to acquire the position via input.	
Forced control (Z-mode)	Forced control helps override automatic mode and is implemented via higher control.	
Calibration	Carry out during initial commissioning. The actuator drives to the top or bottom end position; the measured values are saved.	
Valve seat detection	The actuators have power-dependent seat detection. After calibration, the exact valve stroke is stored in the actuator's memory.	
Foreign body detection	After clogging is detected, three attempts are made to get past clogging. If unsuccessful, the actuator continues to following the positioning signal only within a limited range, and the LED blinks red.	
Modbus RTU (RS-485), not galvanically isolated	Setpoint 0...100 % valve position Actual value 0...100 % for valve position Override control Open / Close / Min / Max / Stop Setpoint monitoring and backup mode	SAY61P03/MO

Type summary

Type	Item No.	Stroke	Positioning force	Operating voltage	Positioning signal	Spring return time	Positioning time	LED	Manual adjuster	Auxiliary functions
SAY31P03 ¹⁾	S55150-A132	25 mm	200 N	AC 230 V	3-position	-	30 s	-	Push and fix	3)
SAY61P03 ²⁾	S55150-A133			AC 24 V	DC ... 10 V DC 4...20 mA 0...1000 Ω			Yes		4) 5)
SAY61P03/MO ²⁾	S55150-A145			DC 24 V	Modbus RTU			-		5)
SAY81P03 ²⁾	S55150-A134				3-position			-		

1) Approbation: CE

2) Approbation: CE, UL

3) Optional accessories: Auxiliary switch

4) Position feedback, forced control, characteristic changeover

5) Optional accessories: Auxiliary switch, sequence control, control action changeover

Scope of delivery

Actuators, valves and accessories are supplied in individual packs.

Accessories/spare parts

Electrical accessories

Type	Auxiliary switch ASC10.51	Function module AZX61.1
Item No.	S55845-Z103	S55845-Z107
SAY31P..	Max. 2	Max. 1
SAY61P..		-
SAY61P../MO		
SAY81P..		Max. 1



Mechanical accessory

Type	Weather shield ASK39.1
Item No.	S55845-Z109

Ordering (example)

Type	Stock number	Designation	Number of pieces
SAY81P03	S55150-A134	Actuator	1
ASC10.51	S55845-Z103	Auxiliary switch	1

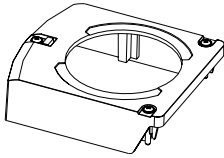
Spare parts

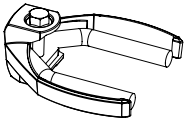
Product number /Stock number	Housing cover	Screw (valve stem coupling)
8000060843		
		U-bracket 

Equipment combinations

Valve type		DN	H ₁₀₀ [mm]	$\dot{V}_{Min.}$ [l/h]	\dot{V}_{m100} [l/h]	Δp_{min} [kPa]	Data sheet
VPI46.40F9.5Q	S55264-V129	40	15	1370	9500	25	N4855
VPI46.50F12Q	S55264-V130	50		1400	11500	36	

Product documentation

Title	Contents	Document ID
Actuators SAX..., SAY..., SAV..., SAL.. for valves	Basic documentation: Detailed information on stroke actuators including Modbus types Stroke actuators for valves with 20/40 mm stroke and rotary actuators for butterfly valves	CE1P4040en
Electromotive actuators for valves SAY..P..	Data sheet: Product description SAY..P..	A6V10628469
Electromotive actuators for valves SA..., Modbus RTU	Data sheet: Modbus communication profiles	A6V101037195
Mounting instructions G..161../MO and S..6/MO	Mounting instructions: Mounting and installation instructions for Modbus actuators	A5W00027551

Related documents such as environmental declarations, CE declarations, etc., can be downloaded at the following Internet address:

<http://siemens.com/bt/download>

Safety

	⚠ CAUTION
	<p>National safety regulations</p> <p>Failure to comply with national safety regulations may result in personal injury and property damage.</p> <ul style="list-style-type: none"> • Observe national provisions and comply with the appropriate safety regulations.

	⚠ WARNING
	<p>Risk of burns from hot actuator brackets</p> <p>The actuator brackets on heating plants can also become hot from the contact with the hot valve during operation. The temperature of the actuator bracket can reach 100 °C.</p> <p>When servicing the actuator:</p> <ul style="list-style-type: none"> • Switch off both pump and operating voltage. • Close the main shutoff valve in the piping. • Allow the piping to cool off.

Engineering

SAY31P03 / SAY81P03

3-position actuators must be controlled by a controller, see Connection diagrams [→ 13].

SAY61P03

Up to 10 actuators can drive in parallel on a controller output with a rating of 1 mA.
Modulating actuators have an input impedance of 100 kΩ.

SAY61P03/MO

The Modbus converter is designed for analog control at 0...10 V.



Keep the analog signal setting on the actuator as is (switch 1 to OFF); adjustment not permitted.

Mounting

Mounting positions

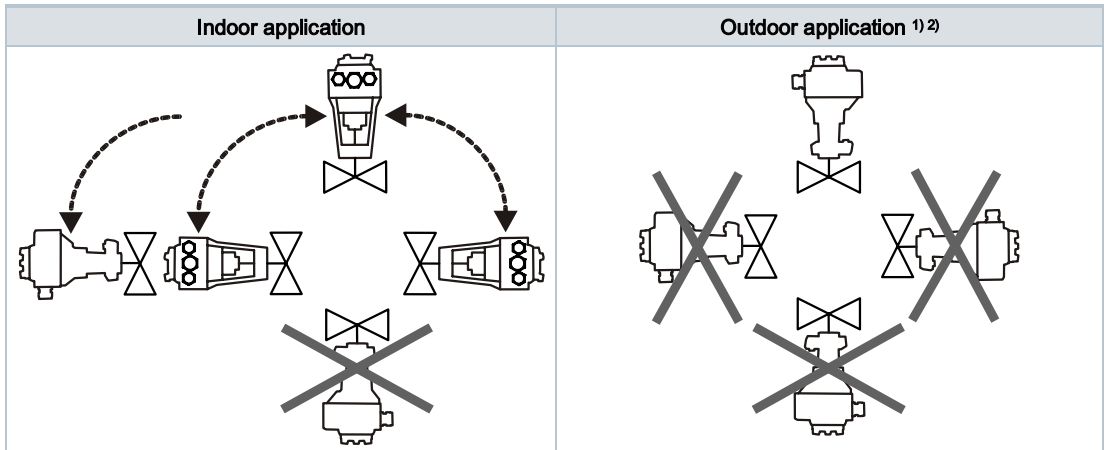

- 1) Only together with weather shield ASK39.2. IP54 housing protection remains unchanged.
- 2) SAY61P../MO is not intended for outdoor use.

Operation

Direction of control action

On valves where the stem retracts to the close position, "direct acting" means that the value is fully closed at positioning signal $Y = 0\text{ V}$ or $Z = 0\ \Omega$ (i.e. 100 %).

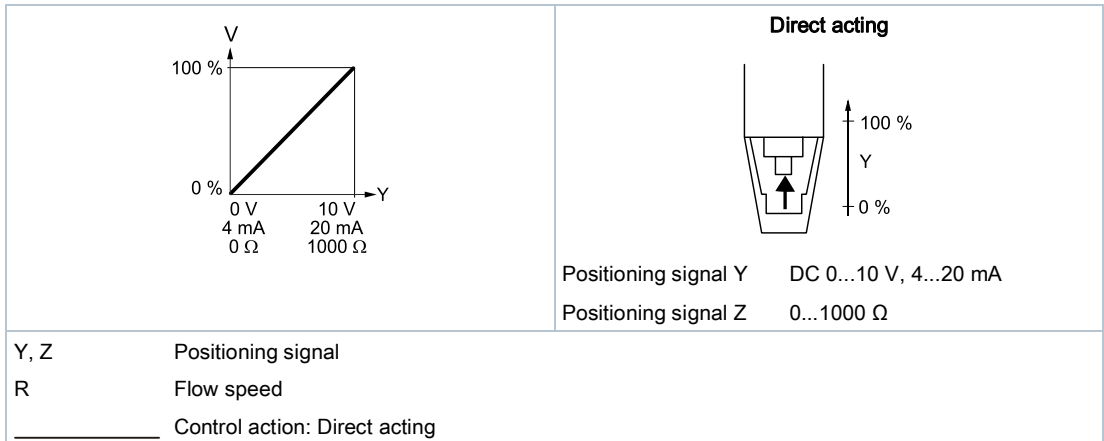

Maintenance

The actuators are maintenance-free.

Disposal



The device is considered an electronic device for disposal in accordance with the European Guidelines and may not be disposed of as domestic garbage.

- Dispose of the device through channels provided for this purpose.
- Comply with all local and currently applicable laws and regulations.

Warranty service

Technical data on specific applications are valid only together with Siemens products listed under "Equipment combinations". Siemens rejects any and all warranties in the event that third-party products are used.

Technical data

Power		
Operating voltage		
SAY31P03		AC 230 V \pm 15%
SAY61P03..		AC 24 V \pm 20 % / DC 24 V +20 % / -15 % (SELV)
SAY81P03		
Frequency		45...65 Hz
External supply line fusing (EU)		<ul style="list-style-type: none"> • Non-renewable fuse 6...10 A slow • Circuit break max. 13 A, tripping characteristic B, C, D to EN 60898 • Power source with current limitation of max. 10 A
Power consumption at 50 Hz		
SAY31P03		6 VA / 3.5 W
SAY61P03	Stem retracts/extends	8 VA / 3.75 W
SAY61P/MO		8.7 VA / 4.25 W
SAY81P03		5 VA / 3.75 W
Typical switch-on current ¹⁾ (3-position actuators)		
SAY31P03		2.3 A
SAY81P03		4.5 A

Operating data	
Positioning times (with the specified nominal stroke)	The positioning time may vary depending on the type of valve (Type summary [→ 3])
SAY31P03, SAY61P03, SAY81P03.	30 s
Positioning force	200 N
Nominal stroke	15 mm
Permissible media temperature (valve fitted)	1...120 °C

Signal inputs		
Positioning signal "Y"		
SAY31P03, SAY81P03		3-position
SAY31P03	Voltage	AC 230 V \pm 15%
SAY81P03		AC 24 V \pm 20% / DC 24 V + 20% / - 15%
SAY61P03		
DC 0...10 V	Power consumption	\leq 0.1 mA
	Input impedance	\geq 100 k Ω
DC 4...20 mA	Power consumption	DC 4...20 mA \pm 1%
	Input impedance	\leq 500 k Ω

Communication SAY61P../MO		
Communication protocol		
Modbus RTU		RS-485, not galvanically isolated
Number of nodes		Max. 32
Address range		1...248 / 255
	Factory setting	255
Transmission formats		1-8-E-1 / 1-8-O-1 / 1-8-N-1 / 1-8-N-2
	Factory setting	1-8-E-1
Baud rates (kbaud)		Auto / 9.6 / 19.2 / 38.4 / 57.6 / 76.8 / 115.2
	Factory setting	Auto
Bus termination		120 Ω electronically switchable
	Factory setting	Off

Parallel connection	
SAY61P03	≤ 10 (depending on controller output)

Forced control		
Z positioning signal		
SAY61P03		R = 0...1000 Ω, G, G0
	R = 0...1000 Ω	Stroke proportional to R
	Z connected to G	Max. stroke 100 % ²⁾
	Z connected to G0	Max. stroke 0 % ²⁾
	Voltage	Max. AC 24 V ± 20 % Max. DC 24 V +20% / -15%
	Power consumption	≤ 0.1 mA

Position feedback		
Position feedback U		
SAY61P03		DC 0...10 V
	Load impedance	> 10 kΩ resistive
	Load	Max. 1 mA

Connection cables		
Wire cross-sectional areas		0.75 mm ² , AWG 20...16 ³⁾
Cable entries		
SAY..P..		<ul style="list-style-type: none"> 2 entries ∅ 20.5 mm (for M20) 1 entry ∅ 25.5 mm (for M25)
SAYP61../MO		
	Fixed connection cable	0.9 m
	Number of cores	5 x 0.75 mm ²

Degree of protection and class		
Housing from vertical to horizontal		IP 54 as per EN 60529 ⁴⁾
Protection class		As per EN 60730
SAY31P03	AC 230 V	II
SAY61P03	AC / DC 24 V	III
SAY81P03		

Environmental conditions			
Operation		IEC 60721-3-3	
	Climatic conditions	Class 3K5	
		Mounting location	Indoors (weather-protected) ⁴⁾
		Temperature, general	5...55 °C
		Humidity (non-condensing)	5...95 % r.h.
Transportation		IEC 60721-3-2	
	Climatic conditions	Class 2K3	
		Temperature	-25...70 °C
		Humidity	< 95% r.h.
Storage		IEC 60721-3-1	
	Climatic conditions	Class 1K3	
		Temperature	-15...55 °C
		Humidity	5...95 % r.h.
Max. media temperature when mounted on valve		120 °C	

Directives and standards		
Product standard		EN 60730-x
Electromagnetic compatibility (field of use)		For residential, commercial, and industrial environments
EU conformity (CE)		A5W00000333 ⁵⁾
RCM conformity	AC 230 V	A5W00000334 ⁵⁾
EAC compliance		Eurasian compliance for all SAY..P..
UL, cUL	AC 230 V	-
	AC / DC 24 V	UL 873 http://ul.com/database ; file number E35198

Environmental compatibility
Product environmental declarations 71 7331 0559 ⁵⁾ und A6V101083254 ⁵⁾ include data on environmentally friendly product design and testing (RoHS compliance, material composition, packaging, environmental benefits, disposal).

Dimensions
See Dimensions [→ 15]

Accessories ⁶⁾		
Auxiliary switch ASC10.51	Switching capacity	AC 24...230 V, 6 (2) A, potential free
External fusing of supply line		<ul style="list-style-type: none"> Non-renewable fuse 6...10 A slow Circuit break max. 13 A, tripping characteristic B, C, D to EN 60898 Power source with current limitation of max. 10 A
US installation, UL & cUL		AC 24 V class 2, 5 A general purpose

- 1) Switching time for RMS value of the sine wave at nominal voltage
- 2) Observe acting direction of DIL switches
- 3) AWG = American wire gauge
- 4) For outdoor operation, always use weather shield ASK39.1, housing protection class IP 54 remains as is. SAY61../MO is not intended for outdoor use.
- 5) Documents can be downloaded at <http://www.siemens.com/bt/download>
- 6) UL-approved component 

Internal Diagrams

SAY31P03

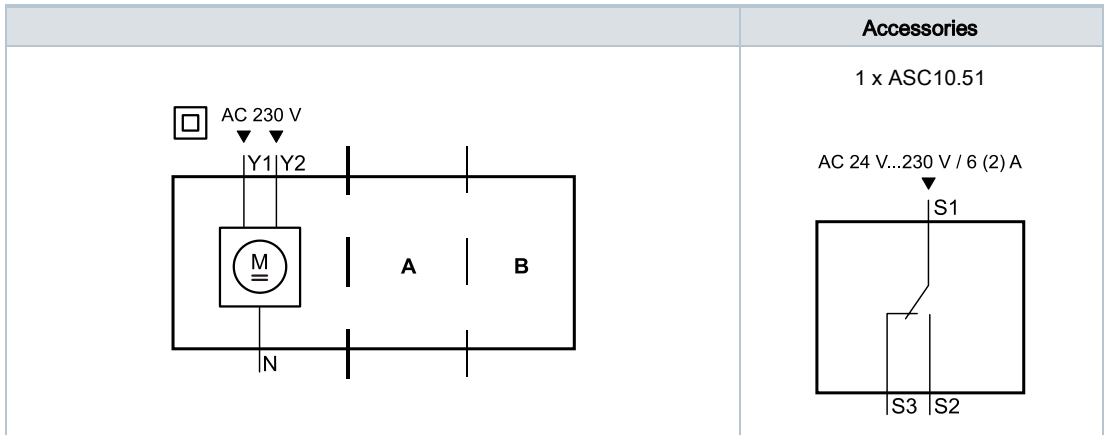

SAY61P..

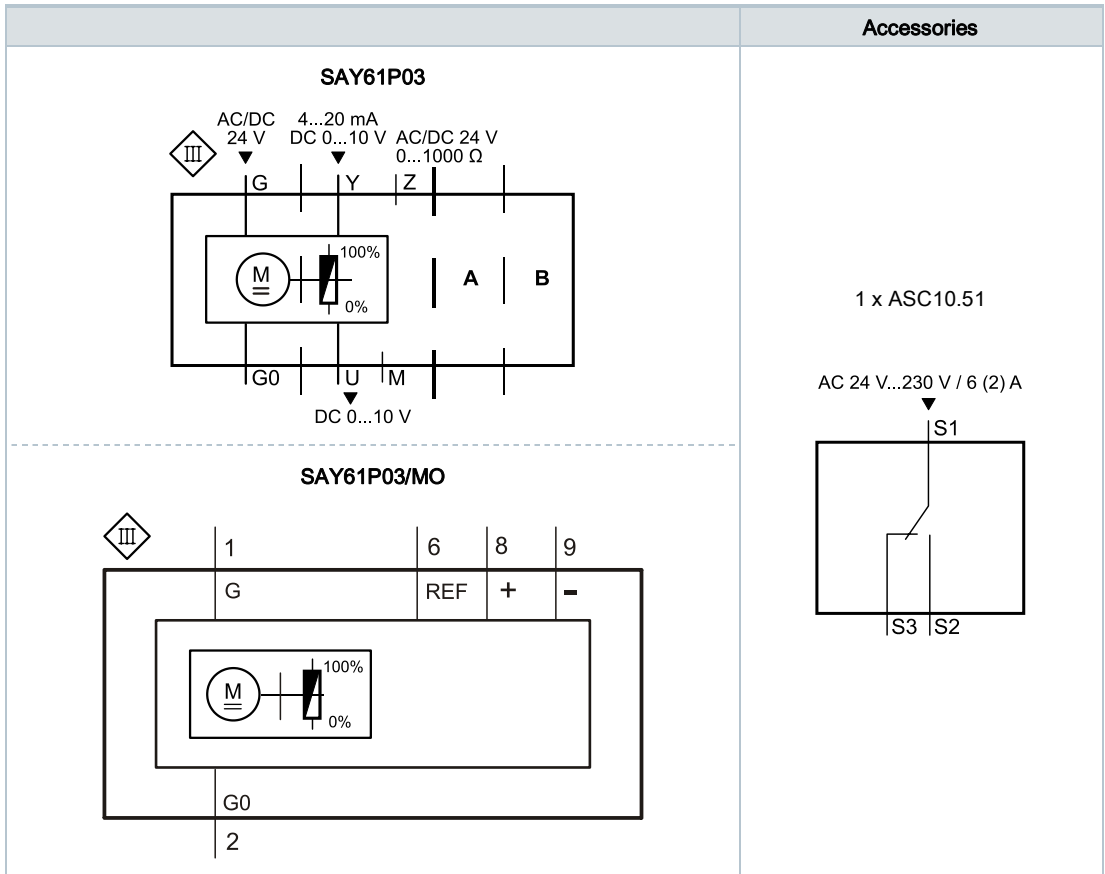

SAY81P03

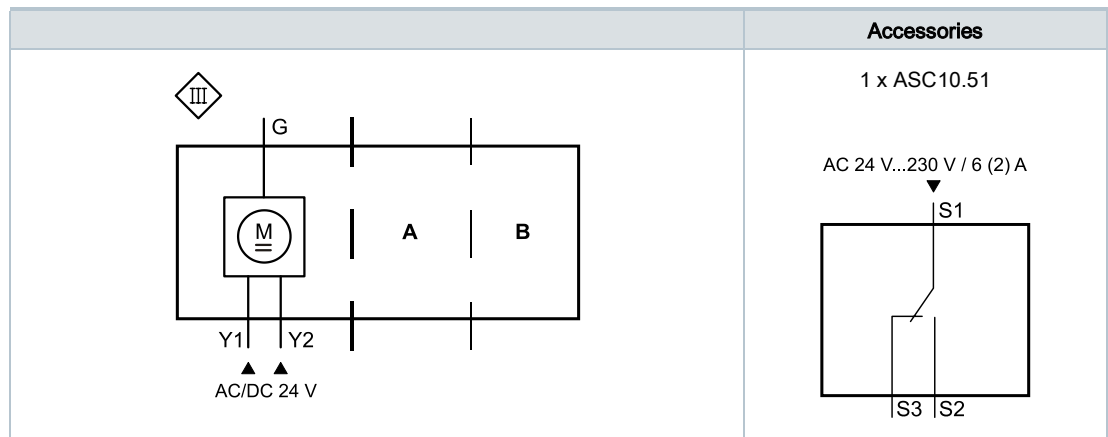

Connection terminals

SAY31P03

	AC 230 V	3-position
N	System neutral (SN)	
Y1	Positioning signal (actuator's stem extends)	
Y2	Positioning signal (actuator's stem retracts)	

SAY61P03

	AC / DC 24 V	D 0...10 V 4...20 mA 0...1000
G0	System neutral (SN)	
G	System potential (SP)	
Y	Positioning signal for DC 0...10 V / 4...20 mA	
M	Measuring neutral	
U	Position feedback DC 0...10 V - (System neutral is measuring ground M)	
Z	Control signal forced control	

SAY61P03/MO

	AC / DC 24 V	Modbus RTU connecting cable
G0	System neutral (SN)	black
G	System potential (SP) AC 24 V / DC 24 V	red
REF	Reference line (Modbus RTU)	violet
+	Bus + (Modbus RTU)	gray
-	Bus - (Modbus RTU)	pink

SAY81P03

	AC / DC 24 V	3-position
G	System potential (SP)	
Y1	Positioning signal (actuator's stem extends)	
Y2	Positioning signal (actuator's stem retracts)	

Connection diagrams

SAY31P03

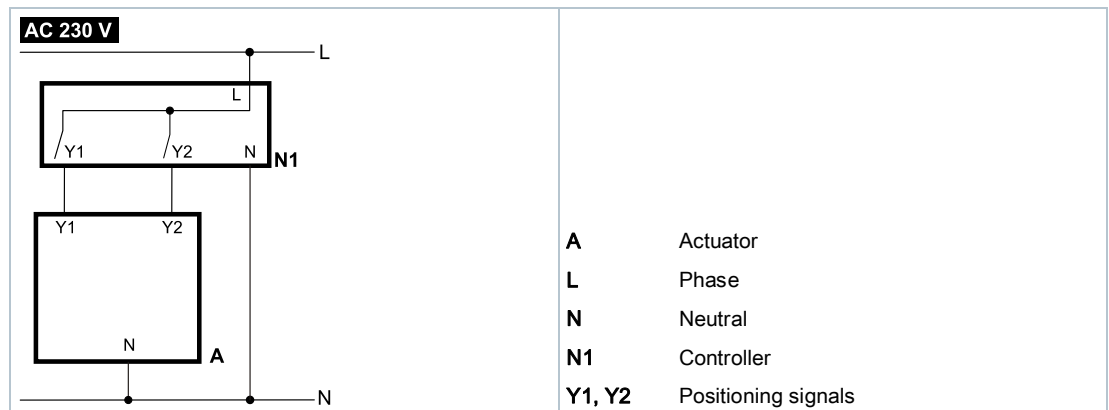

SAY61P03

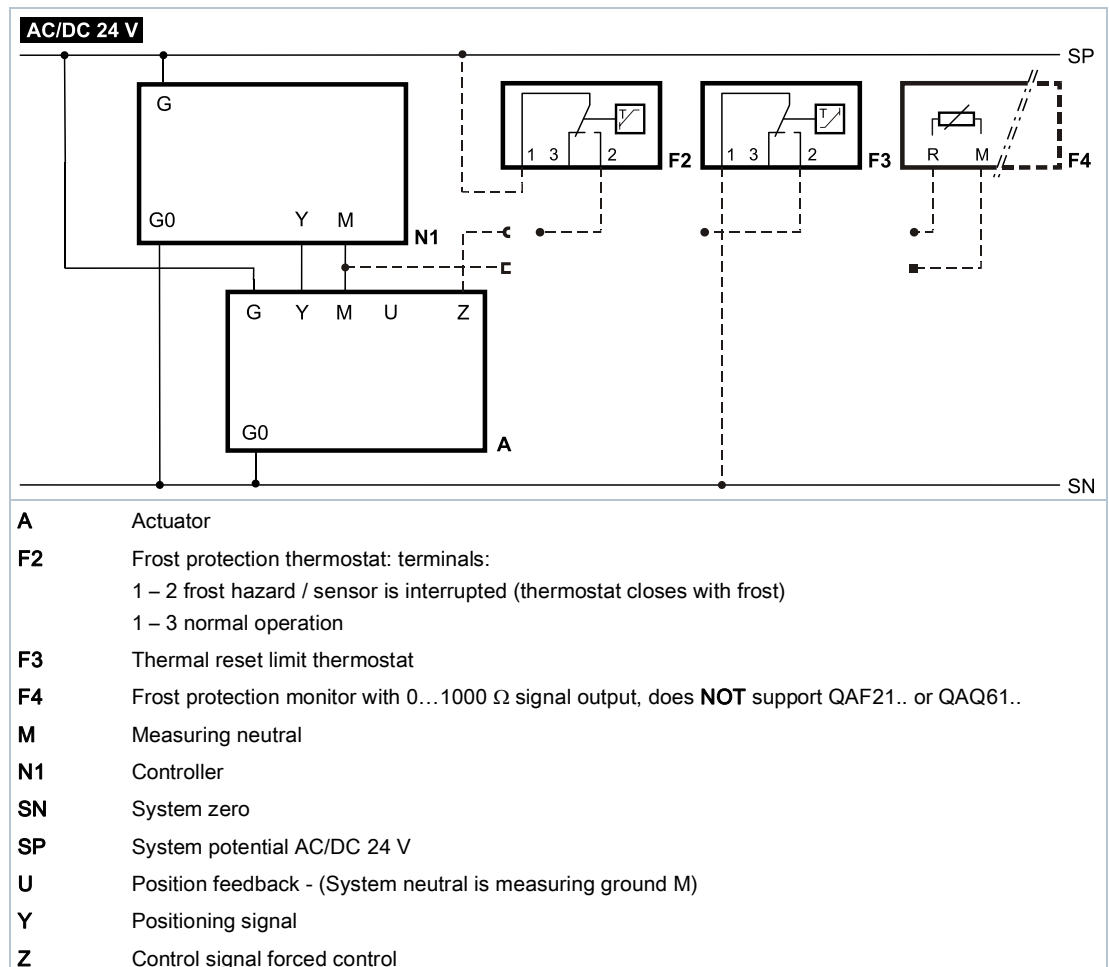

SAY61P03/MO

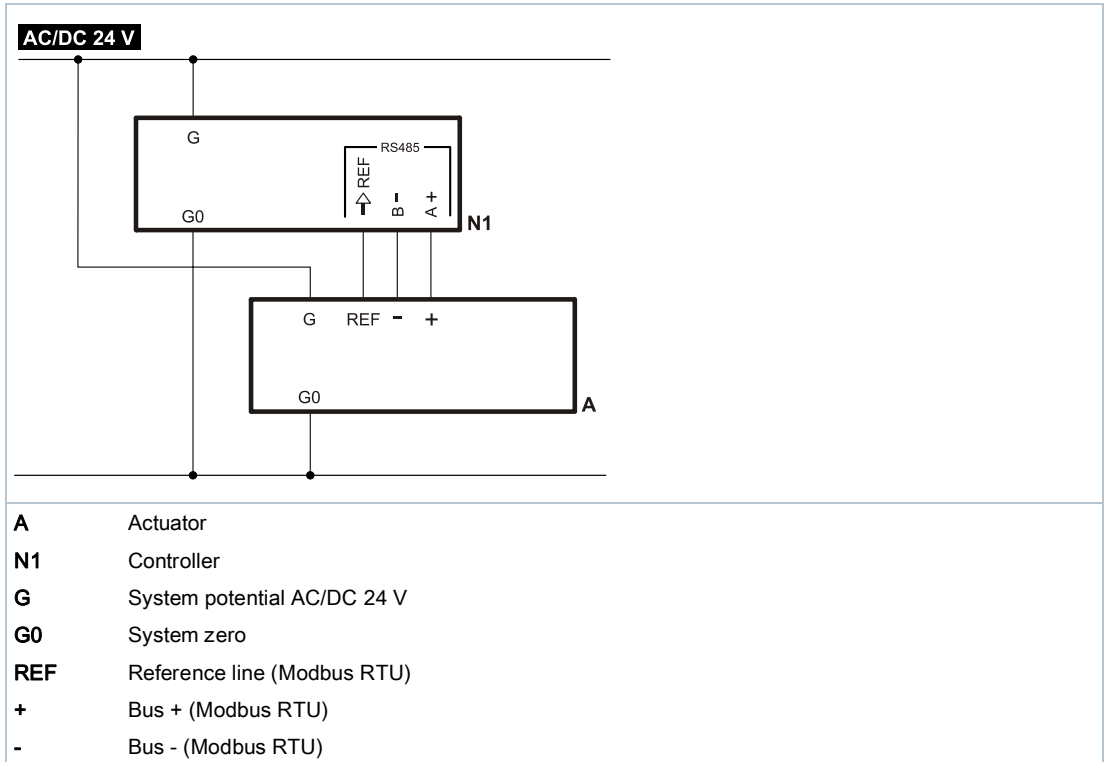

SAY81P03

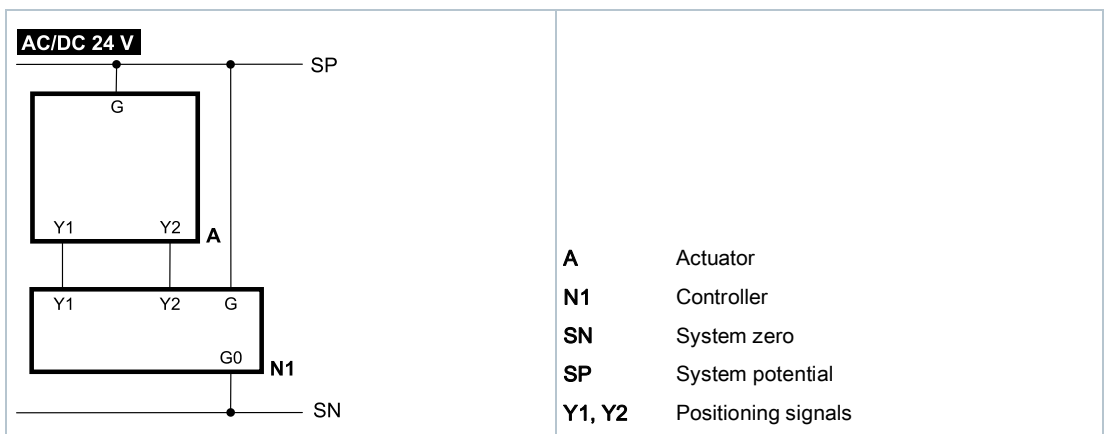

Actuator

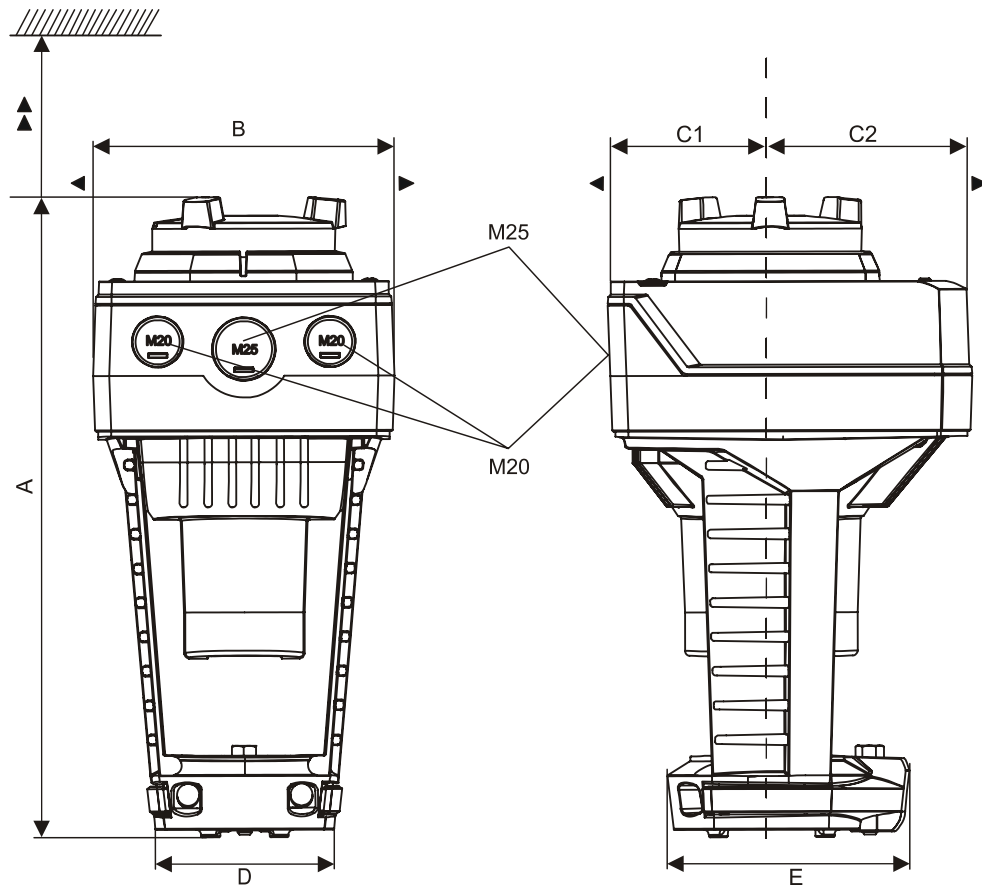

Type	A	B	C	C1	C2	D	E	▶	▶▶	kg
	[mm]									[kg]
SAY..P..	242	124	150	68	82	80	100	100	200	1.780
SAY61P03/MO ¹⁾										2.930
With ASK39.1	267	154	300	200	100	-				2.010

¹⁾ Device has fixed connection cable – left cable entry occupied

External Modbus converter

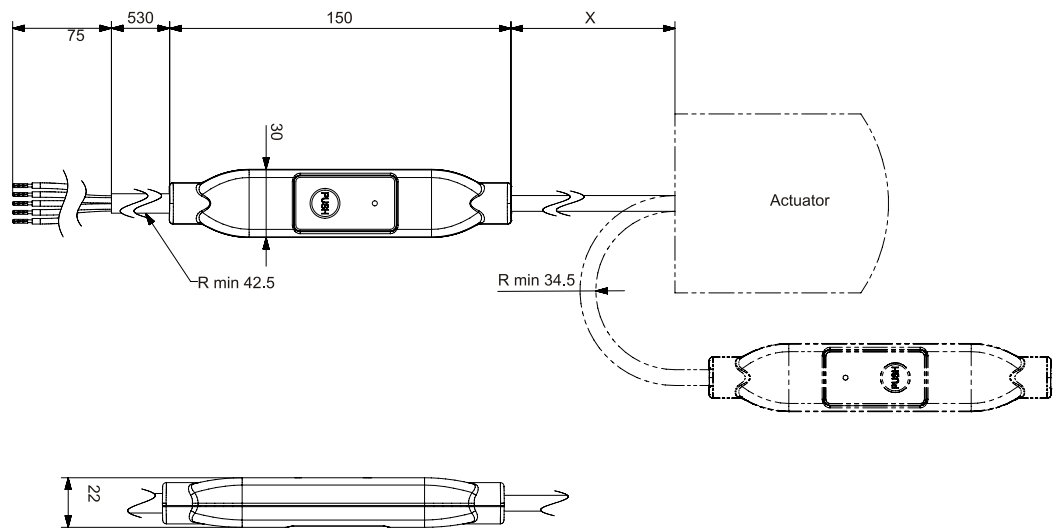

Dimensions in mm

Type	X	kg
	[mm]	[kg]
SAY61P03/MO	250	0.15 ¹⁾

¹⁾ Included in total weight.

Revision numbers

Type	Valid from rev. no.
SAY31P03	..A
SAY61P03	..A
SAY61P03/MO	..A
SAY81P03	..A